

## PROBLEM SOLVING

### Problem

The Manta II will not function:

### To be checked

- Check that your filtration system is working properly and that the multiport valve is in the filtration position.
- Check whether the filter and the skimmer baskets are clean.
- Make sure the main drain is fully closed.
- Shut down the other suction lines to increase the flow into the automatic pool cleaner.
- Check the power of your pump: the minimum flow necessary is approximately 5m<sup>3</sup>/hour.
- Check whether the diaphragm of the automatic pool cleaner is obstructed by debris or is damaged.

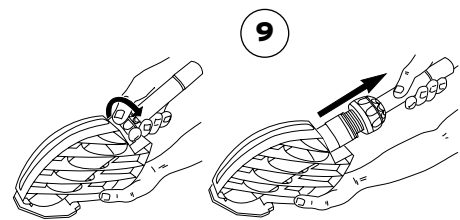

9

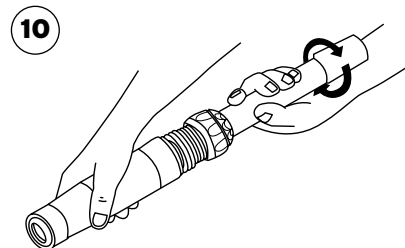

10

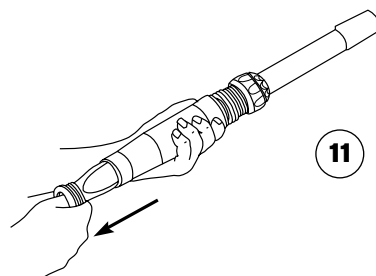

11

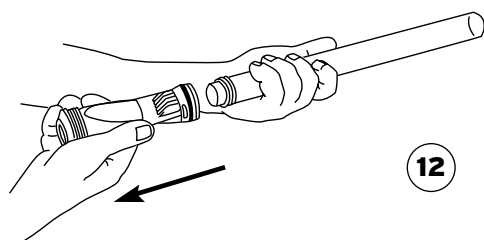

12

## CHANGING THE DIAPHRAGM

### Stage 1 : Removing the diaphragm

1. Hold the main body of the Manta II and disconnect the cassette from the body. Remove the cassette from the body of the Manta II. (9)

2. Whilst holding the outer extension pipe with one hand, unscrew the cassette chamber completely. (10)

3. Take hold of the diaphragm and remove it from its cassette. (11)

4. Withdraw the diaphragm from the inner extension pipe without removing the retaining ring on the diaphragm. (12)

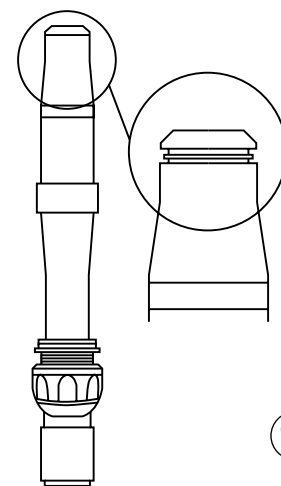

13

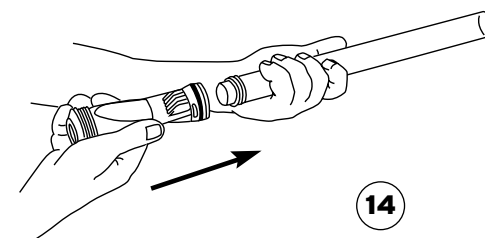

14

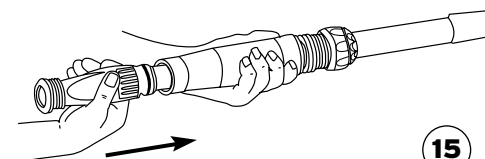

15

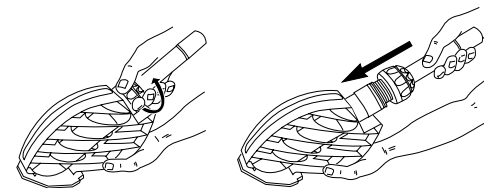

16

### Stage 2 : Adjusting the special Manta II diaphragm

If the opening of the diaphragm's cavity is too large (over 4 mm), but the diaphragm is not damaged or torn, you can solve the problem by leaving one ridge of the diaphragm exposed from the cassette chamber. This may eradicate any performance-related problems – cleaner stopping, coverage problems. (13)

### Stage 3 : Re-fitting the diaphragm

1. Fit the diaphragm to the inner extension pipe. If it is a new diaphragm, do not forget to put the retaining ring in place. (14)

2. Slide the upper part of the inner extension pipe (end opposite the diaphragm) into the lower part of the cassette. The diaphragm must fit perfectly into the lower part of the cassette. (15)

3. Screw the cassette chamber to the cleaner's outer extension pipe. Do not over tighten.

4. Reinsert the cassette into the body and tighten the outer extension pipe / cassette unit, until it has clicked into place. (16)

**PROBLEM SOLVING**

**Problem**

The Manta II moves very slowly and air bubbles appear in the flow:

**To be checked**

- Check the system is tight: between the automatic pool cleaner and hose, between each of the hose sections, between the hose and the valve, between the valve and the skimmer.

The Manta II jams against the ladder or steps:

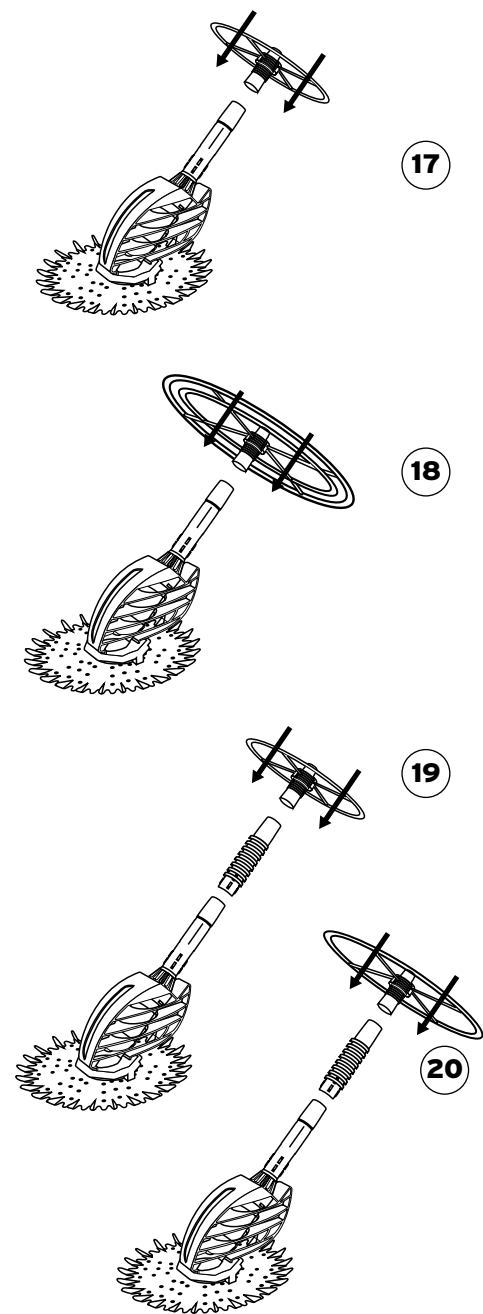

The problem is undoubtedly because the Manta II is not assembled in the way best suited to the shape and obstructions in your pool.

**You have four options:**

- You can fit the small circular deflector to the hose adapter immediately after the cleaner (17),
- You can fit the large circular deflector instead of the small one with the hose adapter immediately after the cleaner (18),
- You can also fit the small circular deflector to the hose adapter, after the short hose fixed to the cleaner (19),
- Lastly, you can fit the large circular deflector to the hose adapter after the short hose fixed to the cleaner (20),

If none of these options resolves the problem, connect the hose to the vacuum point the furthest away from the steps, or shorten the hose to prevent it from coming to rest on the steps.

**PROBLEM SOLVING**

**Problem**

The Manta II does not clean all parts of the pool:

**To be checked**

- To ensure that the entire pool is cleaned the filtration system operating time can be reduced. For example, 6 hours filtration in two hour sessions will give better coverage of the pool than single 6 hour filtering session.
- Make sure your hose is long enough and add sections if necessary.
- Direct the inlet jets towards the bottom of the pool.
- Check the condition of the hose (see storage advice page 16).

The Manta II will not stay on the bottom of the pool:

- Make sure the hose weight is correctly installed (see diagram 5).

The Manta II jams on the main sump:

- Close the main drain.
- Check whether the main drain grill is properly fixed.

The Manta II jams against the light:

- Fit the light correctly.

The Manta II is over the water line:

- Use the control valve or adjust the opening of the skimmers to regulate the flow of water passing through the automatic pool cleaner.

The Manta II lies down:

- If the automatic pool cleaner is unbalanced, the Manta II must be returned to the manufacturer for repair.